



# SUNTUF® Beehive

## Corrugated Polycarbonate Sheet with a Prismatic Surface

A high-performance impact resistant polycarbonate roofing sheet engineered for professional and residential projects.

SUNTUF Beehive generates diffused light with reduced glare for enhanced comfort.

Hail proof polycarbonate that combines superior strength and durability.

An excellent choice for DIY skylights, carport roofing, and other home improvement projects.

Add modern aesthetics and style to your roofing project while extending its lifespan.

### Typical Applications

- Pergolas and gazebos
- Patio enclosures
- Sunrooms
- Carports
- Covered walkways
- Canopies and overhangs



Easy to Install



Durable Against Impact



Superior Strength



Optimized Light & Shade Balance



Reduced Rain Noise



UV Protection

Colors

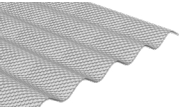
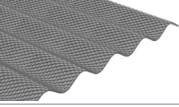
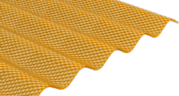
Color	LT [%]	SHGC
 Clear	87	0.86
 Bronze	33	0.53
 Grey	60	0.73
 Gold	20	0.4

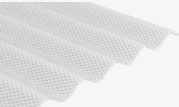

 Solar Ice	25	0.38
 Solar Control	20	0.32
 Solar Olympic	25	0.44
 Cool	65	0.54

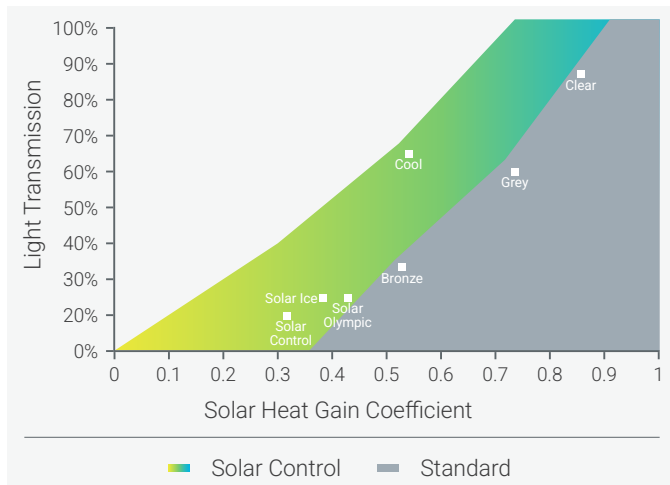

Product Availability

Textures	Prismatic-honeycomb
Thickness	2.8 mm
Width	1045 mm
Profile	76/18 Iron/Sinus 

Accessories

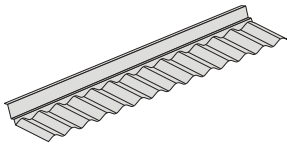
Accessory	Dimensions [mm]
 Head Wall	1,200 x 150 x 80
 Side Wall	1,270 x 130 x 50
 Ridge Cap	1,270 x 150 x 150
 Dual Action Screw	



Scan For Installation Guide



www.palram.com

In as much as Palram Industries has no control over the use to which others may put the material, it does not guarantee that the same results as those described herein will be obtained. Each user of the material should make his own tests to determine the material's suitability for his own particular use. Statements concerning possible or suggested uses of the materials described herein are not to be construed as constituting a license under any Palram Industries patent covering such use or as recommendations for use of such materials in the infringement of any patent. Palram Industries or its distributors cannot be held responsible for any losses incurred through incorrect installation of the material. In accordance with our company policy of continual product development you are advised to check with your local Palram Industries supplier to ensure that you have obtained the most up to date information.

©1997 Palram Industries Ltd. | SUNTUF® is a trademark of Palram Industries Ltd.

